

# Digital Door Lock

## M114F-PC

KEES

### Feature

- Fingerprint Recognition
- Push Pull Handle
- Pin Access
- RFID
- Voice Guide
- Auto-locking
- Mechanical key
- Chinese Mortise





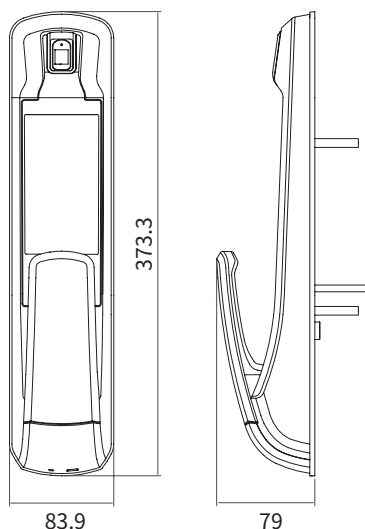





### Dimensions

Unit : mm



## Specifications

Handle Type	Push Pull	
Unlocking Methods	Iris Recognition	N/A
	Finger Print Recognition	Max. 100 USERS
	RFID Card	2ea (Available Mifare type Max. 50ea)
	Password	6 ~ 13 digit number
Mechanical Key	2 ea	
Door Thickness	40 ~ 50 mm (option : 60 ~ 100 mm)	
Back Set / Space	70.5mm/44mm	
Power	DC 6V (1.5V AA Alkaline batteries x 4ea or 8ea)	
Battery Life (Approximated Average - 10 times per day)	12 months(manual w/up & w/o network) ~ 10 months(Automatic Wake up & Using RF, Network options)	
Emergency Battery	Micro USB / DC5V	
Material	Al die casting & ABS mold	
Weight(kg)	4.5	
Dimension (WxHxD)	Outer:W x H x D(mm)	83.9 X 373.3 X 79
	Inner: W x H x D(mm)	84.1 X 374.2 X 80
	Strike Box W x D x Strike H(mm)	24 x 240 x 19.5
	Mortise W x H x Mortise D(mm)	24 x 240 x 106
Optional	BLE, RF	

-  Durable door lock without A/S
-  Durable metal body
-  Auto lock, re-lock, double lock function
-  Use your password safely with imaginary function & security function
-  Multi-level volume control, optional silence function
-  Emergency power function
-  One-touch directional handle
-  Prevent malfunction due to incorrect insertion of battery
-  High Voltage Protection
-  Auto unlock on fire